 Total Relax



 Lift



 Roller System



Asia

Asia

100%
MADE IN ITALY

IT

Struttura Legno rivestito da uno strato di poliuretano e meccanica in metallo.

Imbottitura Poliuretano espanso ecologico a densità differenziata rivestito da una falda di dacron .

Rivestimento Pelle, ecopelle, microfibra e tessuto.

Piedi Legno colore wengè.

Optional Pulsantiera a bracciolo.
Kit supporto lombare BF15

EN

Structure Wood covered with polyurethane and metal mechanism.

Padding Ecological polyurethane foam with different densities covered by a dacron layer.

Cover Leather, faux leather, Microfibre, fabric.

Feet In wood color wengè.

Optional Armrest control unit.
BF15 lumbar support kit.

FR

Structure Bois recouvert d'une couche de polyuréthane et mécanique en métal

Garnissage Mousse de polyuréthane écologique en différentes densités recouverte d'une couche de Dacron

Revêtement Cuir, cuir écologique, microfibre et tissu

Pieds Bois couleur wengè.

En option Pupitre sur l'accoudoir.
Kit de support lombaire BF15.

DE

Struktur Polyurethanverkleidetes Holz mit Metallmechanismus

Polsterung Umweltfreundlicher Polyurethanschaum mit differenzierter Dichte in Dacronwatte

Bezug Leder, Ökoleder, Mikrofaser und Stoff

Füße Holz Farbe Wenge'.

Optional Bedienblende auf Armlehne.
Nierenstütze BF15.

Asia - Poltrona

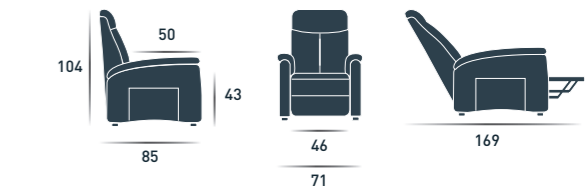

Versioni Relax



Asia Divano



Divano Asia

Versioni Relax

2 Posti



100

126

3 Posti

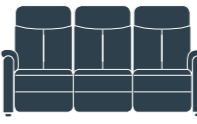

151

175

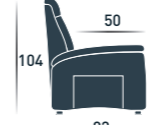

Kit Vibro



2 Posti-1Relax DX



2 Posti-1Relax SX



2 Posti-2Relax



3 Posti-1Relax DX



3 Posti-1Relax SX



3 Posti-1Relax DX

Violetta

Violetta

100%
MADE IN ITALY



IT

Struttura	Legno rivestito da uno strato di poliuretano e meccanica in metallo.
Imbottitura	Poliuretano espanso ecologico a densità differenziata rivestito da una falda di dacron .
Rivestimento	Pelle, ecopelle, microfibra e tessuto.
Piedi	Legno colore argento e wengè.

EN

Structure	Wood covered with polyurethane and metal mechanism.
Padding	Ecological polyurethane foam with different densities covered by a dacron layer.
Cover	Leather, faux leather, Microfibre, fabric.
Feet	In wood color: wengè, siver.

FR

Structure	Bois recouvert d'une couche de polyuréthane et mécanique en métal
Garnissage	Mousse de polyuréthane écologique en différentes densités recouverte d'une couche de Dacron
Revêtement	Cuir, cuir écologique, microfibre et tissu
Pieds	Bois couleur argent et wengé.

DE

Struktur	Polyurethanverkleidetes Holz mit Metallmechanismus
Polsterung	Umweltfreundlicher Polyurethanschaum mit differenzierter Dichte in Dacronwatte
Bezug	Leder, Ökoleder, Mikrofaser und Stoff
Füße	Holz Farbe Silber und Wenge'.

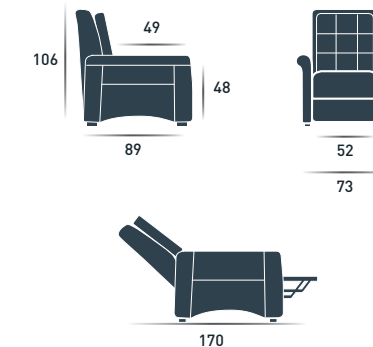

Violetta



 Total Relax

 Lift

Versioni Relax disponibili / Relax versions available / Versions Relax disponibles / Verfügbare Relax-Versionen

- 
 Relax 1 Mot.
- 
 Relax 2 Mot.
- 
 Lift 1 Mot.
- 
 Lift 2 Mot.
- 
 Relax 1 Mot.
 KIT 5 VIBRO
- 
 Lift 1 Mot.
 KIT 5 VIBRO
- 
 Relax 2 Mot.
 KIT 5 VIBRO
- 
 Lift 2 Mot.
 KIT 5 VIBRO

Viola

Viola

100%
MADE IN ITALY

IT

- Struttura** Legno rivestito da uno strato di poliuretano e meccanica in metallo.
- Imbottitura** Poliuretano espanso ecologico a densità differenziata rivestito da una falda di dacron .
- Rivestimento** Pelle, ecopelle, microfibra e tessuto.
- Piedi** Legno colore argento e wengè.

EN

- Structure** Wood covered with polyurethane and metal mechanism.
- Padding** Ecological polyurethane foam with different densities covered by a dacron layer.
- Cover** Leather, faux leather, Microfibre, fabric.
- Feet** In wood color: wengè, siver.

FR

- Structure** Bois recouvert d'une couche de polyuréthane et mécanique en métal
- Garnissage** Mousse de polyuréthane écologique en différentes densités recouverte d'une couche de Dacron
- Revêtement** Cuir, cuir écologique, microfibre et tissu
- Pieds** Bois couleur argent et wengé.

DE

- Struktur** Polyurethanverkleidetes Holz mit Metallmechanismus
- Polsterung** Umweltfreundlicher Polyurethanschaum mit differenzierter Dichte in Dacronwatte
- Bezug** Leder, Ökoleder, Mikrofaser und Stoff
- Füße** Holz Farbe Silber und Wenge'.

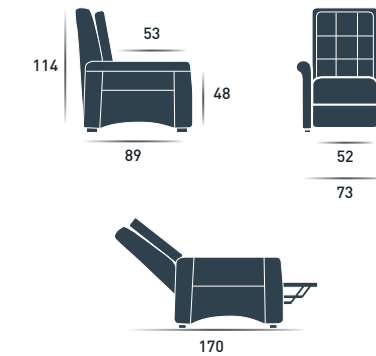

Viola



Versioni Relax disponibili / Relax versions available / Versions Relax disponibles / Verfügbare Relax-Versionen



spazi@relax
wellness solutions

Verdi

Verdi

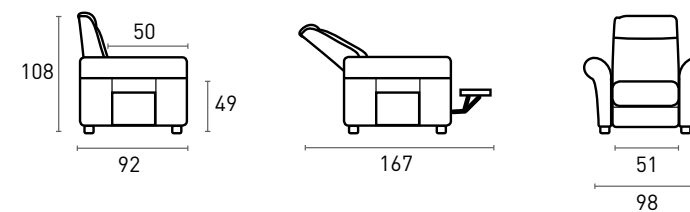

ITA

Struttura

Legno rivestito da uno strato di poliuretano e meccanica in metallo.

Imbottitura

Poliuretano espanso ecologico a densità differenziata rivestito da una falda di dacron. Seduta e schienale in "memory foam".

Rivestimento

Pelle, ecopelle, microfibra e tessuto.

Piedi

In legno nelle tonalità: wengè, ciliegio, rovere sbiancato.

ENG

Structure

Wood covered with polyurethane and metal mechanism.

Padding

Ecological polyurethane foam with different densities covered by a Dacron layer. Seat and back in "memory foam".

Cover

Leather, Faux leather, microfibre, fabric.

Feet

In wood, color: wengè, cherry, bleached oak.

Versioni Relax disponibili

Lift 1 motore



Lift 1 motore + kit 5 vibromassaggi



Lift 2 motori



Lift 2 motori + kit 5 vibromassaggi



Lift 1 motore + massaggio Shiatsu MF60



Relax 1 motore



Relax 1 motore + kit 5 vibromassaggi



Relax 2 motori



Relax 2 motori + kit 5 vibromassaggi



Relax 1 motore + massaggio Shiatsu MF60



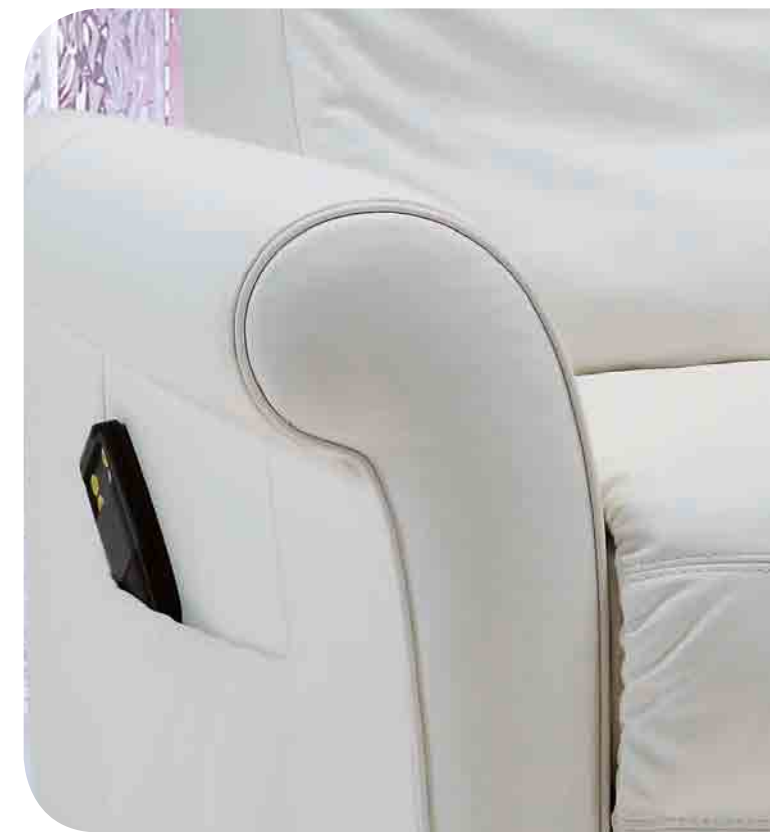

Verdi

Verbena

Verbena

100%
MADE IN ITALY



IT

- Struttura** Legno rivestito da uno strato di poliuretano e meccanica in metallo.
- Imbottitura** Poliuretano espanso ecologico a densità differenziata rivestito da una falda di dacron .
- Rivestimento** Pelle, ecopelle, microfibra e tessuto.
- Piedi** Legno colore wengè.

EN

- Structure** Wood covered with polyurethane and metal mechanism.
- Padding** Ecological polyurethane foam with different densities covered by a dacron layer.
- Cover** Leather, faux leather, Microfibre, fabric.
- Feet** In wood color: wengè.

FR

- Structure** Bois recouvert d'une couche de polyuréthane et mécanique en métal
- Garnissage** Mousse de polyuréthane écologique en différentes densités recouverte d'une couche de Dacron
- Revêtement** Cuir, cuir écologique, microfibre et tissu
- Pieds** Bois couleur wengé.

DE

- Struktur** Polyurethanverkleidetes Holz mit Metallmechanismus
- Polsterung** Umweltfreundlicher Polyurethanschaum mit differenzierter Dichte in Dacronwatte
- Bezug** Leder, Ökoleder, Mikrofaser und Stoff
- Füße** Holz Farbe Wenge'.

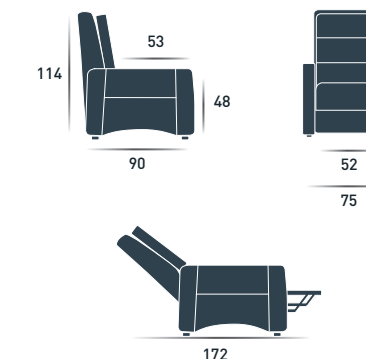

Verbena



 Total Relax

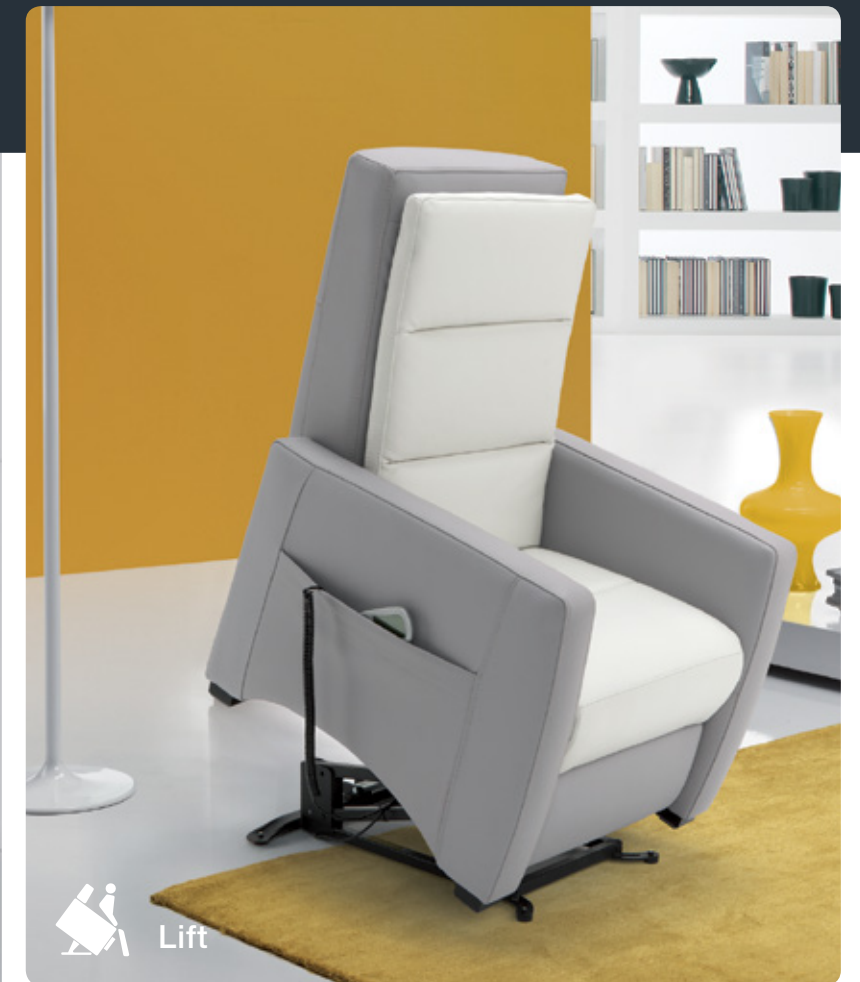

 Lift



 TV

Versioni Relax disponibili / Relax versions available / Versions Relax disponibles / Verfügbare Relax-Versionen



Relax 2 Mot.
Shiatsu MF400 + 1 Vibro

Relax 2 Mot.
Shiatsu MF450 + 1 Vibro

Lift 2 Mot.
Shiatsu MF400 + 1 Vibro

Lift 2 Mot.
Shiatsu MF450 + 1 Vibro



 Total Relax



 Lift



 TV



Rossini

Rossini

100%
MADE IN ITALY

IT

Struttura Legno rivestito da uno strato di poliuretano e meccanica in metallo.

Imbottitura Poliuretano espanso ecologico a densità differenziata rivestito da una falda di dacron .

Rivestimento Pelle, ecopelle, microfibra e tessuto.

Piedi Legno colore wengè.

Optional Pulsantiera a bracciolo.
Kit supporto lombare BF15

EN

Structure Wood covered with polyurethane and metal mechanism.

Padding Ecological polyurethane foam with different densities covered by a dacron layer.

Cover Leather, faux leather, Microfibre, fabric.

Feet In wood color wengè.

Optional Armrest control unit.
BF15 lumbar support kit.

FR

Structure Bois recouvert d'une couche de polyuréthane et mécanique en métal

Garnissage Mousse de polyuréthane écologique en différentes densités recouverte d'une couche de Dacron

Revêtement Cuir, cuir écologique, microfibre et tissu

Pieds Bois couleur wengé.

En option Pupitre sur l'accoudoir.
Kit de support lombaire BF15.

DE

Struktur Polyurethanverkleidetes Holz mit Metallmechanismus

Polsterung Umweltfreundlicher Polyurethanschaum mit differenzierter Dichte in Dacronwatte

Bezug Leder, Ökoleder, Mikrofaser und Stoff

Füße Holz Farbe Wenge'.

Optional Bedienblende auf Armlehne.
Nierenstütze BF15.

Rossini - Poltrona

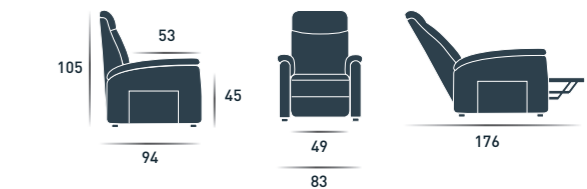

Versioni Relax

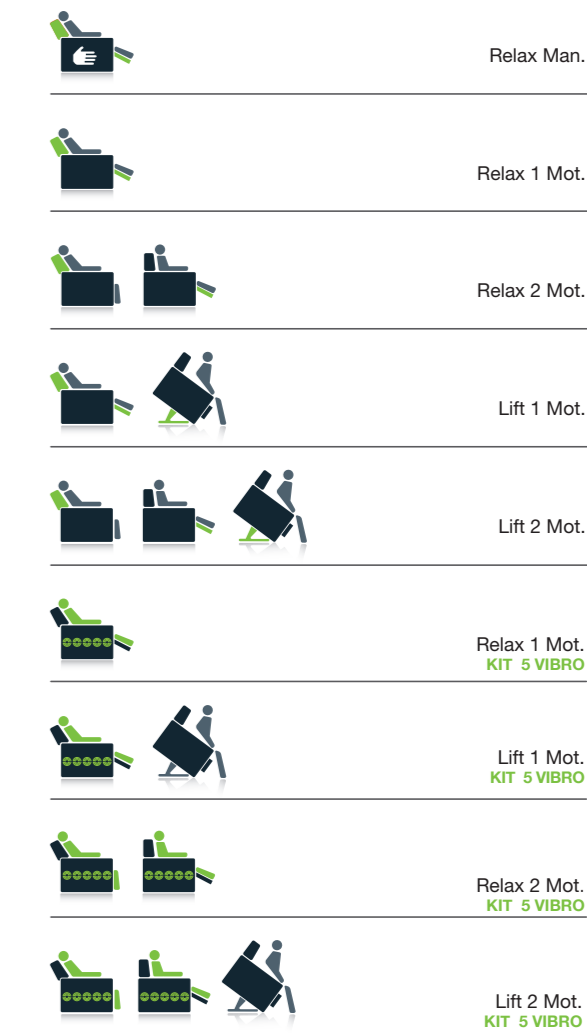

Rossini Divano



Divano Rossini

Versioni Relax

2 Posti



101
135

3 Posti



152
186

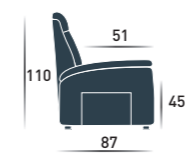

51
87

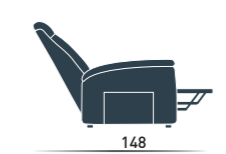

45
148

Kit Vibro



2 Posti-1Relax DX



2 Posti-1Relax SX



2 Posti-2Relax



3 Posti-1Relax DX



3 Posti-1Relax SX



3 Posti-1Relax DX

Reha

Reha

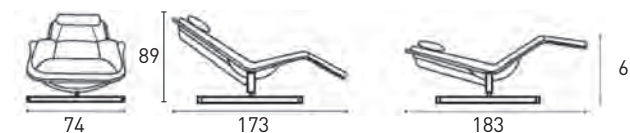

ITA

Struttura

Legno rivestito da uno strato di poliuretano e meccanica in metallo

Imbottitura

Poliuretano espanso ecologico a densità differenziata rivestito da una falda di dacron

Rivestimento

Pelle, ecopelle, microfibra e tessuto

Finiture

Legno nelle tonalità wengè, rovere sbiancato

Piedi

Struttura in metallo

ENG

Structure

Wood covered with polyurethane and metal mechanism

Padding

Ecological polyurethane foam with different densities covered by a Dacron layer

Cover

Leather, Faux leather, microfibre, fabric

Finishing

In wood, color wengè, bleached oak

Feet

Metal frame

Versioni Relax disponibili

Relax 1 motore con movimento basculante - massaggio Shiatsu





Reha

Prisma

Prisma

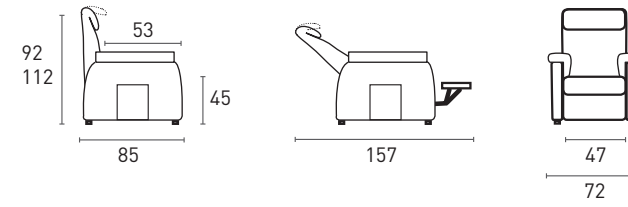

ITA

Struttura

Legno rivestito da uno strato di poliuretano e meccanica in metallo

Imbottitura

Poliuretano espanso ecologico a densità differenziata rivestito da una falda di dacron

Rivestimento

Pelle, ecopelle, microfibra e tessuto

Piedi

Legno colore argento e wengè

Caratteristica principale

Poggiatesta regolabile per un maggior comfort in posizione relax

ENG

Structure

Wood covered with polyurethane and metal mechanism

Padding

Ecological polyurethane foam with different densities covered by a Dacron layer

Cover

Leather, Faux leather, microfibre, fabric

Feet

In wood color: wengè, silver

Main feature

Adjustable headrest to improve the comfort of the relax position

Versioni Relax disponibili

Lift 1 motore



Lift 2 motori



Relax 1 motore



Relax 2 motori



Roller System

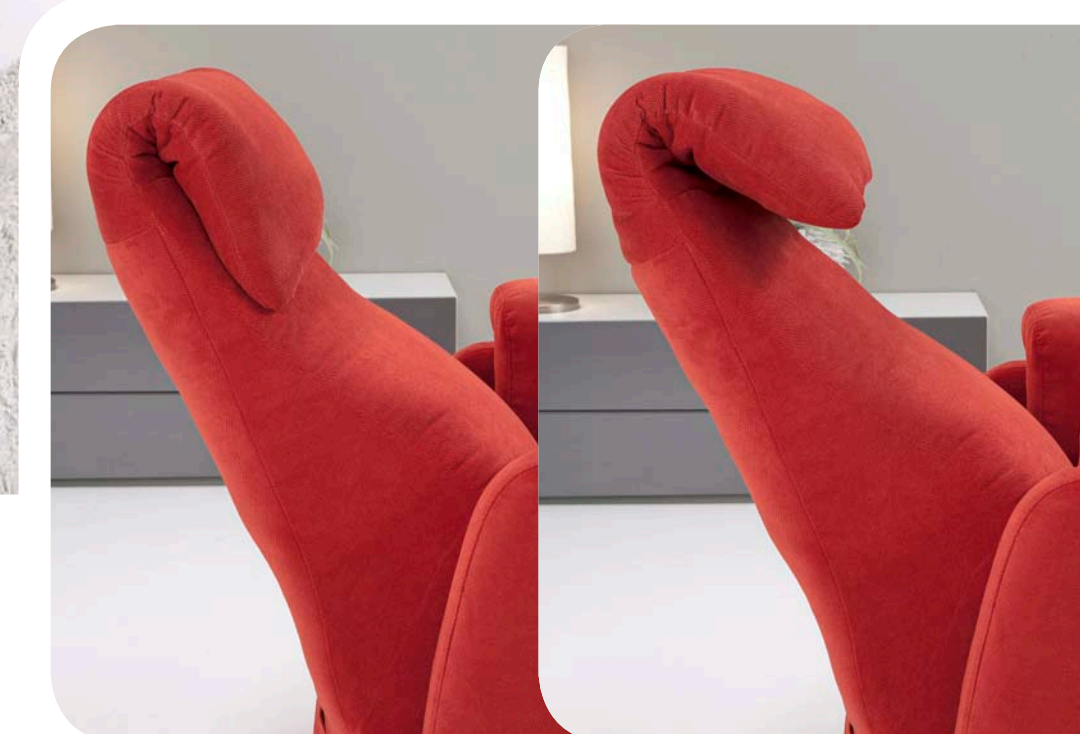

Prisma

Paris

100%
MADE IN ITALY



IT

- Struttura** Legno rivestito da uno strato di poliuretano e meccanica in metallo.
- Imbottitura** Poliuretano espanso ecologico a densità differenziata rivestito da una falda di dacron .
- Rivestimento** Pelle, ecopelle, microfibra e tessuto.
- Piedi** Legno colore argento o wengè.
- Optional** Pulsantiera a bracciolo.
Kit supporto lombare BF15.

EN

- Structure** Wood covered with polyurethane and metal mechanism.
- Padding** Ecological polyurethane foam with different densities covered by a dacron layer.
- Cover** Leather, faux leather, Microfibre, fabric.
- Feet** In wood color: silver, wengè.
- Optional** Armrest control unit.
BF15 lumbar support kit.

FR

- Structure** Bois recouvert d'une couche de polyuréthane et mécanique en métal
- Garnissage** Mousse de polyuréthane écologique en différentes densités recouverte d'une couche de Dacron
- Revêtement** Cuir, cuir écologique, microfibre et tissu
- Pieds** Bois couleur argent et wengé.
- En option** Pupitre sur l'accoudoir.
Kit de support lombaire BF15.

DE

- Struktur** Polyurethanverkleidetes Holz mit Metallmechanismus
- Polsterung** Umweltfreundlicher Polyurethanschaum mit differenzierter Dichte in Dacronwatte
- Bezug** Leder, Ökoleder, Mikrofaser und Stoff
- Füße** Holz Farbe Silber und Wenge'.
- Optional** Bedienblende auf Armlehne.
Nierenstütze BF15.

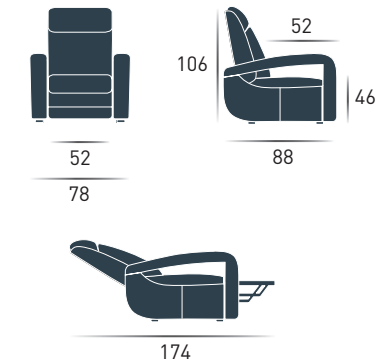

Paris



 Total Relax

Versioni Relax disponibili / Relax versions available / Versions Relax disponibles / Verfügbare Relax-Versionen



Relax 1 Mot.



Relax 2 Mot.



Lift 1 Mot.



Lift 2 Mot.



Relax 1 Mot.
KIT 5 VIBRO



Lift 1 Mot.
KIT 5 VIBRO



Relax 2 Mot.
KIT 5 VIBRO



Lift 2 Mot.
KIT 5 VIBRO



Relax 1 Mot.
Shiatsu MF60



Lift 1 Mot.
Shiatsu MF60

spazirelax
wellness solutions

Pagoda

Pagoda

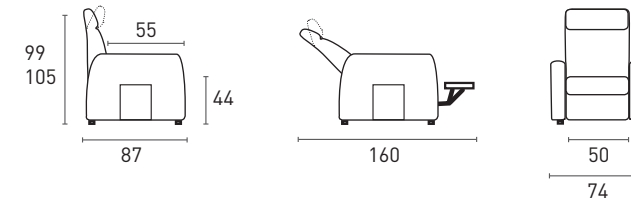

ITA

Struttura

Legno rivestito da uno strato di poliuretano e meccanica in metallo

Imbottitura

Poliuretano espanso ecologico a densità differenziata rivestito da una falda di dacron

Rivestimento

Pelle, ecopelle, microfibra e tessuto

Piedi

Legno colore argento e wengè

Caratteristica principale

Poggiatesta regolabile per un maggior comfort in posizione relax

ENG

Structure

Wood covered with polyurethane and metal mechanism

Padding

Ecological polyurethane foam with different densities covered by a Dacron layer

Cover

Leather, Faux leather, microfibre, fabric

Feet

In wood color: wengè, silver

Main feature

Adjustable headrest to improve the comfort of the relax position

Versioni Relax disponibili

Lift 1 motore



Relax 1 motore



Lift 1 motore + kit 5 vibromassaggi



Relax 1 motore + kit 5 vibromassaggi



Lift 2 motori



Relax 2 motori



Lift 2 motori + kit 5 vibromassaggi



Relax 2 motori + kit 5 vibromassaggi

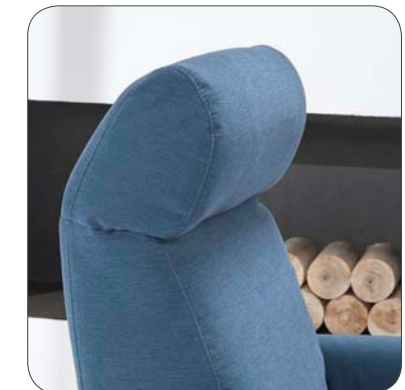



Pagoda

Kubrik

Kubrik

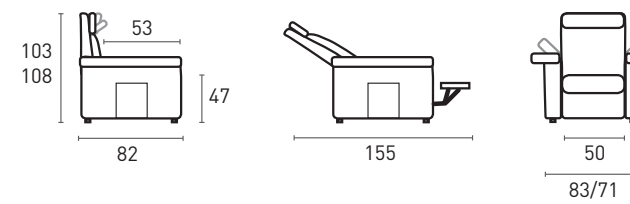

ITA

- Struttura** Legno rivestito da uno strato di poliuretano e meccanica in metallo
- Imbottitura** Poliuretano espanso ecologico a densità differenziata rivestito da una falda di dacron
- Rivestimento** Pelle, ecopelle, microfibra e tessuto
- Piedi** Legno
- Caratteristica principale** Altezza braccioli regolabile a scatti per una ideale postura delle braccia e per ridurre gli ingombri
Poggiatesta regolabile per un maggior comfort in posizione relax

ENG

- Structure** Wood covered with polyurethane and metal mechanism
- Padding** Ecological polyurethane foam with different densities covered by a Dacron layer
- Cover** Leather, Faux leather, microfibre, fabric
- Feet** Wood
- Main feature** Adjustable height of the armrests in different positions in order to improve the comfort and reduce the width of the chair
Adjustable headrest to improve the comfort of the relax position

Versioni Relax disponibili

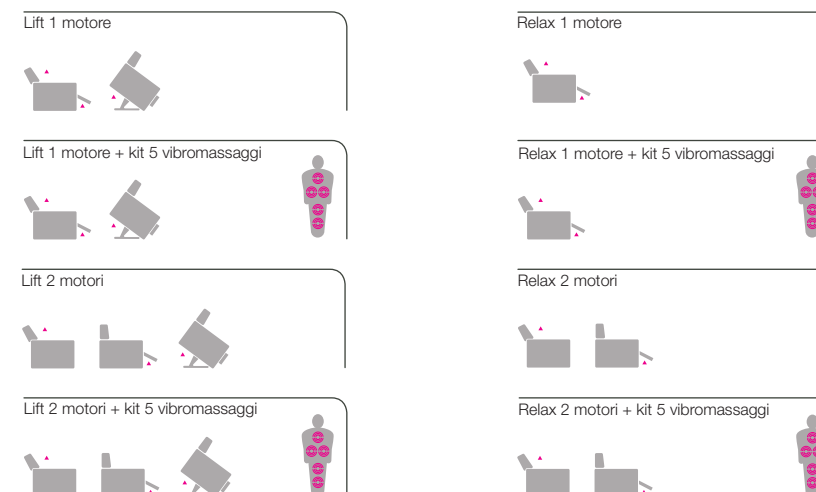



Kubrik

Giano

Giano

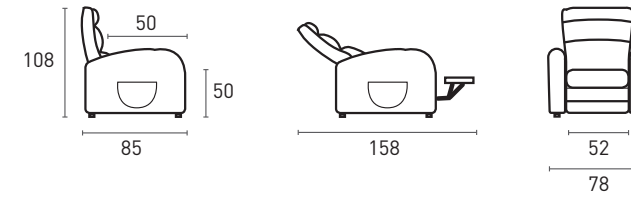

ITA

- Struttura** Legno rivestito da uno strato di poliuretano e meccanica in metallo
- Imbottitura** Poliuretano espanso ecologico a densità differenziata rivestito da una falda di dacron
- Rivestimento** Pelle, ecopelle, microfibra e tessuto
- Piedi** PVC
- Optional** Plumette
Fodere copibracciali

ENG

- Structure** Wood covered with polyurethane and metal mechanism
- Padding** Ecological polyurethane foam with different densities covered by a Dacron layer
- Cover** Leather, Faux leather, microfibre, fabric
- Feet** PVC
- Optionals** Plumette
Cover for arms

Versioni Relax disponibili

Lift 1 motore



Relax 1 motore



Relax Manuale



Lift 1 motore + kit 5 vibromassaggi



Relax 1 motore + kit 5 vibromassaggi



Lift 2 motori



Relax 2 motori



Lift 2 motori + kit 5 vibromassaggi



Relax 2 motori + kit 5 vibromassaggi





Giano

Giada

Giada

100%
MADE IN ITALY

IT

Struttura	Legno rivestito da uno strato di poliuretano e meccanica in metallo.
Imbottitura	Poliuretano espanso ecologico a densità differenziata rivestito da una falda di dacron .
Rivestimento	Pelle, ecopelle, microfibra e tessuto.
Piedi	PVC.

EN

Structure	Wood covered with polyurethane and metal mechanism.
Padding	Ecological polyurethane foam with different densities covered by a dacron layer.
Cover	Leather, faux leather, Microfibre, fabric.
Feet	PVC.

FR

Structure	Bois recouvert d'une couche de polyuréthane et mécanique en métal
Garnissage	Mousse de polyuréthane écologique en différentes densités recouverte d'une couche de Dacron
Revêtement	Cuir, cuir écologique, microfibre et tissu
Pieds	PVC.

DE

Struktur	Polyurethanverkleidetes Holz mit Metallmechanismus
Polsterung	Umweltfreundlicher Polyurethanschaum mit differenzierter Dichte in Dacronwatte
Bezug	Leder, Ökoleder, Mikrofaser und Stoff
Füße	PVC.

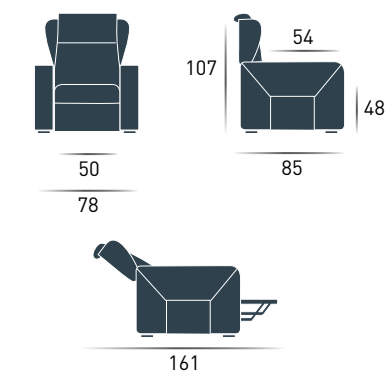

spazi**o**relax
wellness solutions

spazi**o**relax
wellness solutions

Spazio Relax by ITL S.r.l. - 75100 Matera - Z.I. La Martella Lotto C/46
TF +39 0835 256477 - info@spaziorelaxitalia.com | www.spaziorelaxitalia.com

Giada



Versioni Relax disponibili / Relax versions available / Versions Relax disponibles / Verfügbare Relax-Versionen



Relax 1 Mot.



Relax 2 Mot.

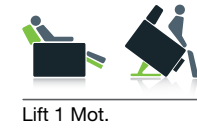

Lift 1 Mot.

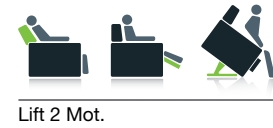

Lift 2 Mot.



Relax 1 Mot.
KIT 5 VIBRO



Lift 1 Mot.
KIT 5 VIBRO



Relax 2 Mot.
KIT 5 VIBRO



Lift 2 Mot.
KIT 5 VIBRO

spazi relax
wellness solutions

Galaxy

Galaxy

100%
MADE IN ITALY

IT

Struttura	Legno rivestito da uno strato di poliuretano e meccanica in metallo.
Imbottitura	Poliuretano espanso ecologico a densità differenziata rivestito da una falda di dacron .
Rivestimento	Pelle, ecopelle, microfibra e tessuto.
Piedi	Struttura in metallo con piatto girevole.

EN

Structure	Wood covered with polyurethane and metal mechanism.
Padding	Ecological polyurethane foam with different densities covered by a dacron layer.
Cover	Leather, faux leather, Microfibre, fabric.
Feet	Metal frame with plate, swivelling.

FR

Structure	Bois recouvert d'une couche de polyuréthane et mécanique en métal
Garnissage	Mousse de polyuréthane écologique en différentes densités recouverte d'une couche de Dacron
Revêtement	Cuir, cuir écologique, microfibre et tissu
Pieds	Structure en métal avec base, pivotant.

DE

Struktur	Polyurethanverkleidetes Holz mit Metallmechanismus
Polsterung	Umweltfreundlicher Polyurethanschaum mit differenzierter Dichte in Dacronwatte
Bezug	Leder, Ökoleder, Mikrofaser und Stoff
Füße	Metallstruktur mit Drehtablet.

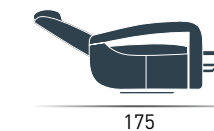
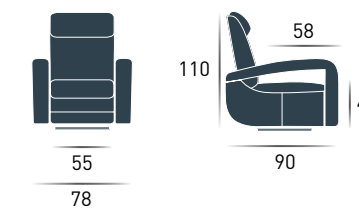

Galaxy



Versioni Relax disponibili / Relax versions available / Versions Relax disponibles / Verfügbare Relax-Versionen



Edera

Edera

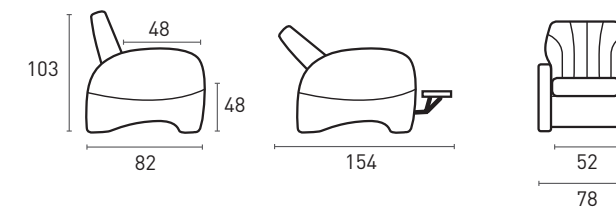

ITA

- Struttura** Legno rivestito da uno strato di poliuretano e meccanica in metallo
- Imbottitura** Poliuretano espanso ecologico a densità differenziata rivestito da una falda di dacron
- Rivestimento** Pelle, ecopelle, microfibra e tessuto
- Piedi** PVC
- Optional** Plumette
Cuscino poggiatesta
Fodere copibracciali
Fodera coprischienale

ENG

- Structure** Wood covered with polyurethane and metal mechanism
- Padding** Ecological polyurethane foam with different densities covered by a Dacron layer
- Cover** Leather, Faux leather, microfibre, fabric
- Feet** PVC
- Optionals** Plumette
Cushion
Cover for arms
Cover for back

Versioni Relax disponibili

<p>Lift 1 motore</p>	<p>Relax 1 motore</p>	<p>Relax manuale</p>
<p>Lift 1 motore + kit 5 vibromassaggi</p>	<p>Relax 1 motore + kit 5 vibromassaggi</p>	
<p>Lift 2 motori</p>	<p>Relax 2 motori</p>	
<p>Lift 2 motori + kit 5 vibromassaggi</p>	<p>Relax 2 motori + kit 5 vibromassaggi</p>	



Edera

Carina

Carina

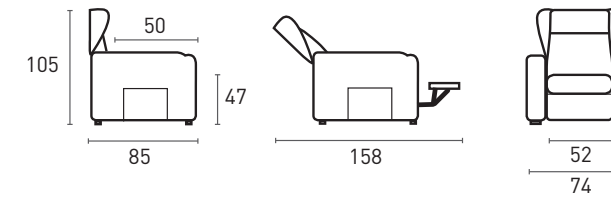

ITA

- Struttura** Legno rivestito da uno strato di poliuretano e meccanica in metallo
- Imbottitura** Poliuretano espanso ecologico a densità differenziata rivestito da una falda di dacron
- Rivestimento** Pelle, ecopelle, microfibra e tessuto
- Piedi** PVC
- Optional** Plumette
Cuscino poggiatesta
Fodere copribraccioli

ENG

- Structure** Wood covered with polyurethane and metal mechanism
- Padding** Ecological polyurethane foam with different densities covered by a Dacron layer
- Cover** Leather, Faux leather, microfibre, fabric
- Feet** PVC
- Optionals** Plumette
Cushion
Cover for arms

Versioni Relax disponibili

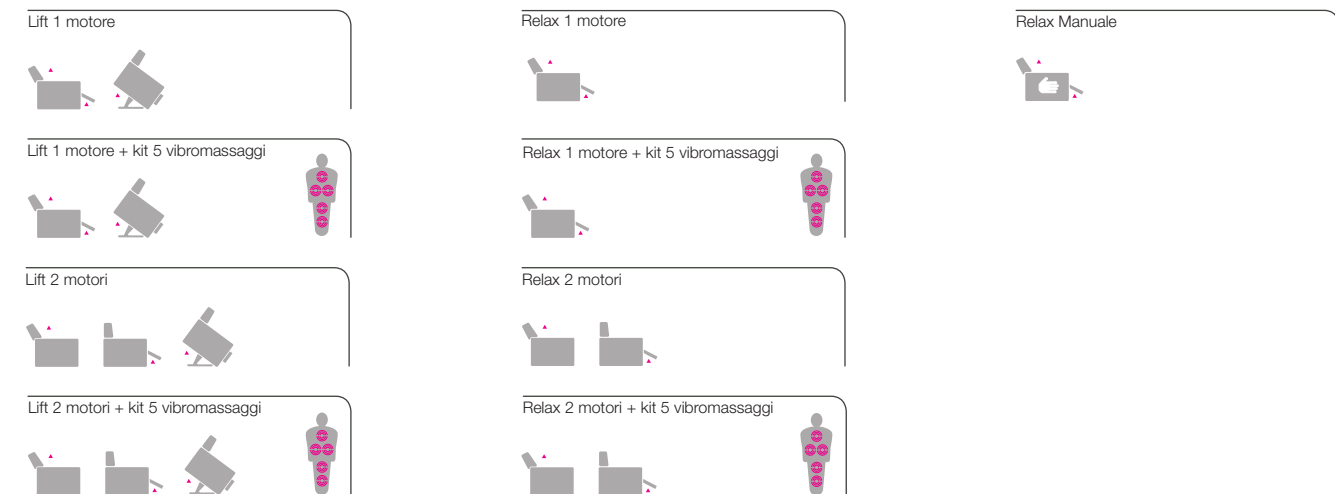



Carina

Botero

Botero

100%
MADE IN ITALY

IT

Struttura	Legno rivestito da uno strato di poliuretano e meccanica in metallo.
Imbottitura	Poliuretano espanso ecologico a densità differenziata rivestito da una falda di dacron .
Rivestimento	Pelle, ecopelle, microfibra e tessuto.
Piedi	PVC.

EN

Structure	Wood covered with polyurethane and metal mechanism.
Padding	Ecological polyurethane foam with different densities covered by a dacron layer.
Cover	Leather, faux leather, Microfibre, fabric.
Feet	PVC.

FR

Structure	Bois recouvert d'une couche de polyuréthane et mécanique en métal
Garnissage	Mousse de polyuréthane écologique en différentes densités recouverte d'une couche de Dacron
Revêtement	Cuir, cuir écologique, microfibre et tissu
Pieds	PVC.

DE

Struktur	Polyurethanverkleidetes Holz mit Metallmechanismus
Polsterung	Umweltfreundlicher Polyurethanschaum mit differenzierter Dichte in Dacronwatte
Bezug	Leder, Ökoleder, Mikrofaser und Stoff
Füße	PVC.

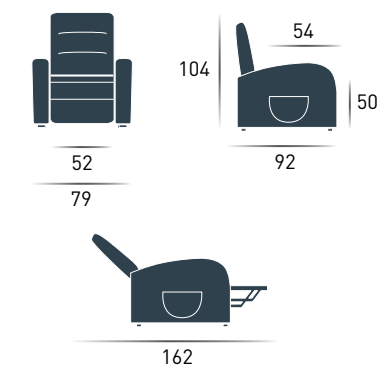

Botero



 Total Relax



 Lift



Versioni Relax disponibili / Relax versions available / Versions Relax disponibles / Verfügbare Relax-Versionen



Relax 1 Mot.



Relax 2 Mot.



Lift 1 Mot.

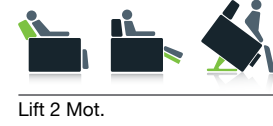

Lift 2 Mot.



Relax 1 Mot.
KIT 5 VIBRO



Lift 1 Mot.
KIT 5 VIBRO

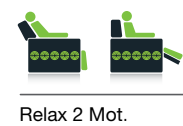

Relax 2 Mot.
KIT 5 VIBRO

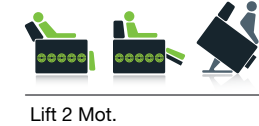

Lift 2 Mot.
KIT 5 VIBRO



Relax 1 Mot.
Shiatsu MF60



Lift 1 Mot.
Shiatsu MF60

spazi@relax
wellness solutions

Bergé Compact

Bergé Compact

100%
MADE IN ITALY

IT

Struttura	Legno rivestito da uno strato di poliuretano e meccanica in metallo.
Imbottitura	Poliuretano espanso ecologico a densità differenziata rivestito da una falda di dacron .
Rivestimento	Pelle, ecopelle, microfibra e tessuto.
Piedi	PVC.
Optional	Rivestimento sfoderabile.

EN

Structure	Wood covered with polyurethane and metal mechanism.
Padding	Ecological polyurethane foam with different densities covered by a dacron layer.
Cover	Leather, faux leather, Microfibre, fabric.
Feet	PVC.
Optional	Removable cover.

FR

Structure	Bois recouvert d'une couche de polyuréthane et mécanique en métal
Garnissage	Mousse de polyuréthane écologique en différentes densités recouverte d'une couche de Dacron
Revêtement	Cuir, cuir écologique, microfibre et tissu
Pieds	PVC.
En option	Revêtement déhoussable

DE

Struktur	Polyurethanverkleidetes Holz mit Metallmechanismus
Polsterung	Umweltfreundlicher Polyurethanschaum mit differenzierter Dichte in Dacronwatte
Bezug	Leder, Ökoleder, Mikrofaser und Stoff
Füße	PVC.
Optional	Abziehbarer Bezug

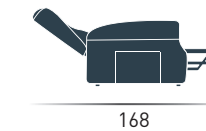
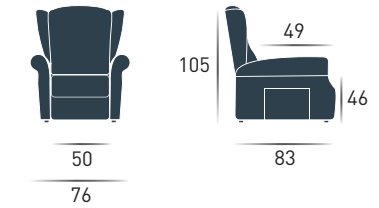

Bergé Compact



Versioni Relax disponibili / Relax versions available / Versions Relax disponibles / Verfügbare Relax-Versionen

- 
 Relax Man.
- 
 Relax 1 Mot.
- 
 Relax 2 Mot.
- 
 Lift 1 Mot.
- 
 Lift 2 Mot.
- 
 Relax 1 Mot.
 KIT 5 VIBRO
- 
 Lift 1 Mot.
 KIT 5 VIBRO
- 
 Relax 2 Mot.
 KIT 5 VIBRO
- 
 Lift 2 Mot.
 KIT 5 VIBRO